

DATASHEET

CAPACITOR CHARGERS – HCK SERIES



TABLE TOP AND RACK MOUNTED MODELS UP TO 7500J/s
CABINET UNITS UP TO 20kJ/s



PRODUCT FEATURES

FUNCTION:

The power supply of the HCK series (High-voltage Chopper power supplies for Capacitors (German – Kondensatoren)) are highly-stable DC power supplies.

High-voltage capacitor chargers are designed specially to meet the requirements of capacitor charging and capacitor conditioning. They therefore have a robust output resistor to be able to withstand the demands of a pulsed load. The control circuit is designed for fast transitions from constant current to constant voltage operation

CHARACTERISTICS:

- The equipment is suitable for both continuous and trickle charging.
- Capacitors with a resistive component are also suitable as loads.
- Charging is achieved using an adjustable constant current without overshoot.
- Voltage and current settings are made using a ten-turn potentiometer with a lockable precision knob.
- Display of the output voltage and current set points is possible with the VIEW SET push-button.
- The specified maximum charging power is achieved when charging from zero volt (0) to the rated voltage. The HCK series can operate in circuits where the load capacitor is fully discharged with each pulse, or in circuits where the load capacitor is only partially discharged with each pulse. In partial discharge applications the HCK can deliver significantly more power than according to its type label nominal rating without any damage to the unit.
- Feedback after reaching the end of charge voltage is provided using an LED on the front panel and via a voltage-isolated interface – “Trigger” BU2 (optocoupler output).
- The charging process can either be continuous or triggered using the external trigger input (optocoupler, input 12–24V).
- The equipment is permanently protected against short-circuit and arcs.
- Usually, an external protective resistor is not required. It is, however, recommended for applications with very high levels of stored energy.

We will be happy to give you advice - contact us at: sales@fug-elektronik.de or +49 8039 400 77 0.

POSSIBLE OPTIONS:

- Analog programming
- Analog programming, floating
- Computer Interfaces – IEEE 488, RS 232, RS 422, Profibus DP, LAN, USB (more on request)
- Polarity reversal switch available up to 1600J/s (by request for higher powers)
Please specify the output polarity when ordering without polarity reversal switch.
- Interlock
- Message output voltage < 50V
- Display with sample & hold feature for higher repetition rate
- Higher stability and better reproducibility
- Higher repetition frequency
- Fast discharge of the output/ dump switch (Parameters to be specified by customer)
- Roller blades for cabinet units

More options and special solutions on request. Some options may involve changes to the description of the unit - especially concerning the mechanical design. Not all options are compatible with all others. Please ask us for advice.

CAPACITOR CHARGER OPERATING MODES:

The capacitor charger can be operated without limits over the entire working range. Thus, the rated current can be continuously drawn at maximum voltage. If suitable interface options are present, you can choose between LOCAL, ANALOGUE and DIGITAL operating modes.

TECHNICAL SPECIFICATIONS

All data given here apply for voltage and current control during internal operation (LOCAL) and are based on the maximum value of the output voltage.

DIMENSIONS:

Up to 2500 J/s rated power: 19" desktop housing. A special version as 19" rack slide-in unit or with optional rack adapter is available. The height and depth of the capacitor charger depend on its power rating. For higher rated power depending on output voltage: tabletop, slide-in or 19" cabinets. For more details, please refer to the type table at the end of this data sheet.

ELECTRICAL SPECIFICATION:

Mains connection:	Up to 800J/s rated power 230V $\pm 10\%$ 47-63Hz From 1600J/s rated power 400V $\pm 10\%$ 3-phase 47-63Hz Also refer to the details on the nameplate. The N and PE (protective earth) connections are always required!
Protection class:	I
Overvoltage category:	II
Output	Output values, voltage / current, see type table at the of this document.
Short-circuit protection:	The power supply is short-circuit and flash-over proof. The maximum current can be drawn at any output voltage even at short-circuit.
Efficiency:	Approx. 90%
Output polarity:	Positive or negative, also available with a polarity reversal switch, see details on the device or in the equipment card.
Output isolation:	The "0V" terminal is connected to the PE (EARTH). Current return takes place by the screen of the output cable preferably.
Setting range voltage:	With the VOLTAGE ten-turn potentiometer, approx. 0,1% to 100% of the rated value (stable operation from 1%)
Setting range current:	With the CURRENT ten-turn potentiometer, approx. 0,1% to 100% of the rated value (stable operation from 1%)
Setting resolution:	$\pm 1 \times 10^{-3}$ from nominal value with potentiometer on front panel With optional interface: 16 bit or better please refer to our datasheet for interface $\pm 1 \times 10^{-5}$ from nominal value with fine potentiometer on front panel
Displays:	DVM for voltage and current, range ± 20000 LEDs for status messages
Charge voltage reproducibility:	at $\pm 10\%$ Mains voltage change $< \pm 1 \times 10^{-4}$ of rated value over 8h: $< \pm 1 \times 10^{-3}$ of rated value in temperature range of $< \pm 2 \times 10^{-4}/K$ at repetition frequency of $< 10Hz$: $< \pm 1 \times 10^{-3}$ of rated value at repetition frequency of $> 10Hz$: $< \pm 1 \times 10^{-2}$ of rated value
Repetition frequency:	Maximum 10Hz, optional up to 100Hz
Residual ripple of charging current:	Max. 10%pp of the rated value

AMBIENT CONDITIONS:

DATASHEET

CAPACITOR CHARGERS – HCK SERIES



Operation	
Operaton location:	Only for use in dry indoor areas
Temperature:	0 °C to + 40 °C
Humidity:	Max. relative humidity 80% up to 31 °C, decreasing linearly down to 50% relative humidity at 40 °C
Operation altitude:	Altitude up to 2000m above sea level
Pollution degree:	1
Protection class:	IP20
Cooling:	The heat generated in the power supply unit is dissipated by convection or, in the case of high-power units > 400 J/s by forced cooling by ventilation.
Transport / Storage	
Temperature:	0°C bis +50°C
Humidity:	No precipitation and max. relative humidity of 80%
Storage rooms:	Dust-free and dry

DC POWER SUPPLY COMPONENTS

FRONT VIEW WITH CONTROLS:

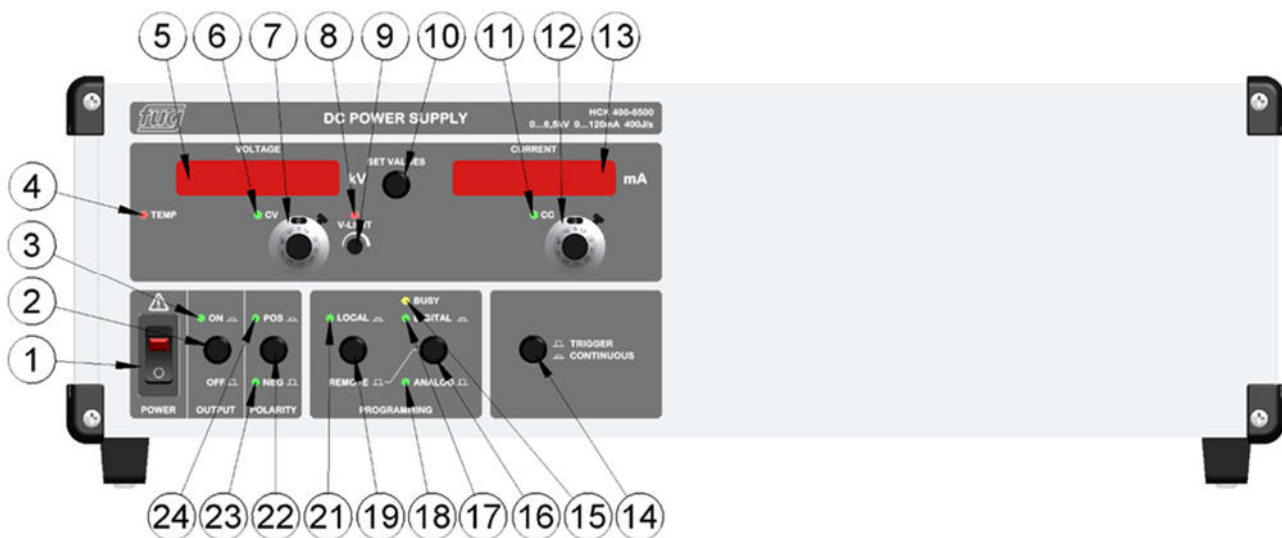

Figure: Front Panel - Sample HCK 400 – 6500 Other dimensions apply to DC power supplies with higher power ratings

1	AC power switch with indicator light Disconnects the power supply from the mains, double-pole switching	2	HV Output ON/OFF button (There is no mains disconnection!)
3	HV ON LED Lights up green when the regulation and therefore the power stage is operating (OUTPUT ON)	4	Over-temperature LED, internal device temperature too high, fan failure or contaminated (Use is type-dependent)
5	Voltage display flashing: Set point; not flashing: Actual value	6	LED for constant voltage mode (Constant Voltage)
7	Lockable ten-turn potentiometer for output voltage adjustment	8	LED for active voltage set-point limit
9	Set-point limit adjustment for voltage V-LIMIT (can be operated with a screwdriver)	10	Push button for SET VALUES switch displays flash when in set point mode
11	LED for constant current mode (Constant Current)	12	Lockable Ten-turn-potentiometer for output current adjustment

DATASHEET

CAPACITOR CHARGERS – HCK SERIES



13	Current display flashing: Set point; not flashing: Actual value	14	Charging Mode – continuous charging or via external trigger
15	(Optional) LED BUSY displays data traffic on the digital interface	16	(Optional) Switching the operation mode between REMOTE/ANALOG and REMOTE/DIGITAL
17	(Optional) LED indicating digital programming active	18	(Optional) LED indicating analog programming active
19	(Optional) Switching the operation mode between LOCAL and REMOTE, control mode	20	Unused
21	(Optional) LED indicating local control mode active	22	(Optional) polarity reversal: Local output polarity selection Without polarity reversal, labelling of polarity using coloured label: RED: POSITIVE; BLUE: NEGATIVE
23	(Optional polarity reversal) LED for negative output voltage set	24	(Optional polarity reversal) LED for positive output voltage set

REAR VIEW WITH SINGLE-PHASE AC INPUT:

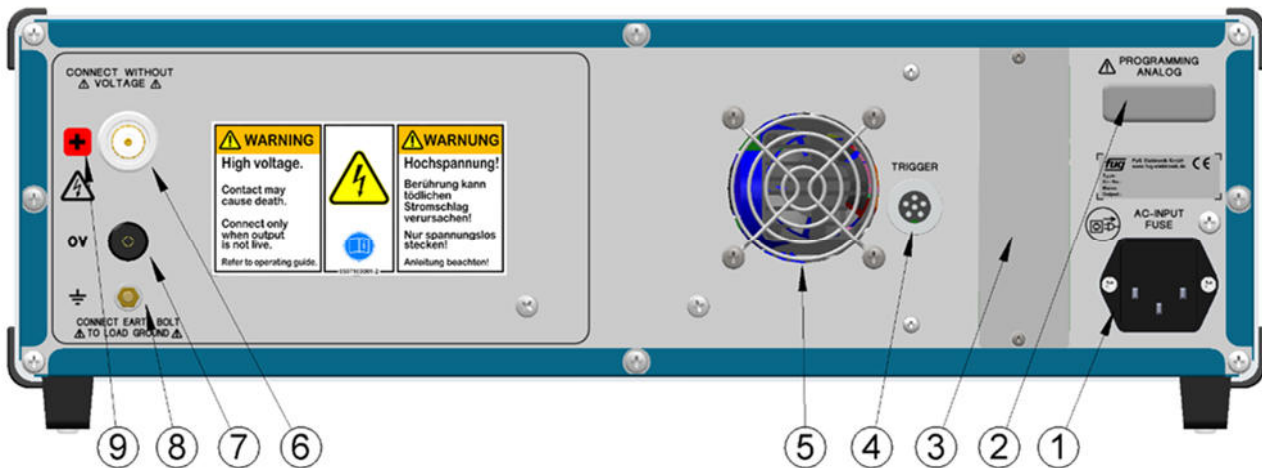

Figure: Single-phase AC input - Sample HCK 400 – 6500 (POSITIV). For DC power supplies with higher power or other voltages, other dimensions apply. The layout of the elements may vary from that shown here.

1	AC input with mains fuses up to 400J/s: IEC connector (as shown) with integrated fuse, from 800J/s, C20 mains cable in accordance with IEC60320-C20, equipped with automatic circuit breaker.
2	(Optional) 15-pin Sub-D connector for analog programming
3	(Optional) Slot for digital interface (e.g.: IEEE-488, RS232, USB, LAN, etc.)
4	Trigger Socket (Trigger input and “Charge Complete” optocoupler output)
5	Air outlet by forced cooling (depending on model)
6	HV output
7	0 V load connection, internally connected to the 0 V of the electronics. This 0 V connection is permanently connected to the housing, the shielding of the output cable and to the PE conductor.
8	Earth bolt: This connection must be connected to the ground of the load!
9	Polarity indications: RED: POSITIVE BLUE: NEGATIVE RED/BLUE: Option POLARITY REVERSAL

DATASHEET

CAPACITOR CHARGERS – HCK SERIES



REAR VIEW WITH THREE-PHASE AC INPUT:

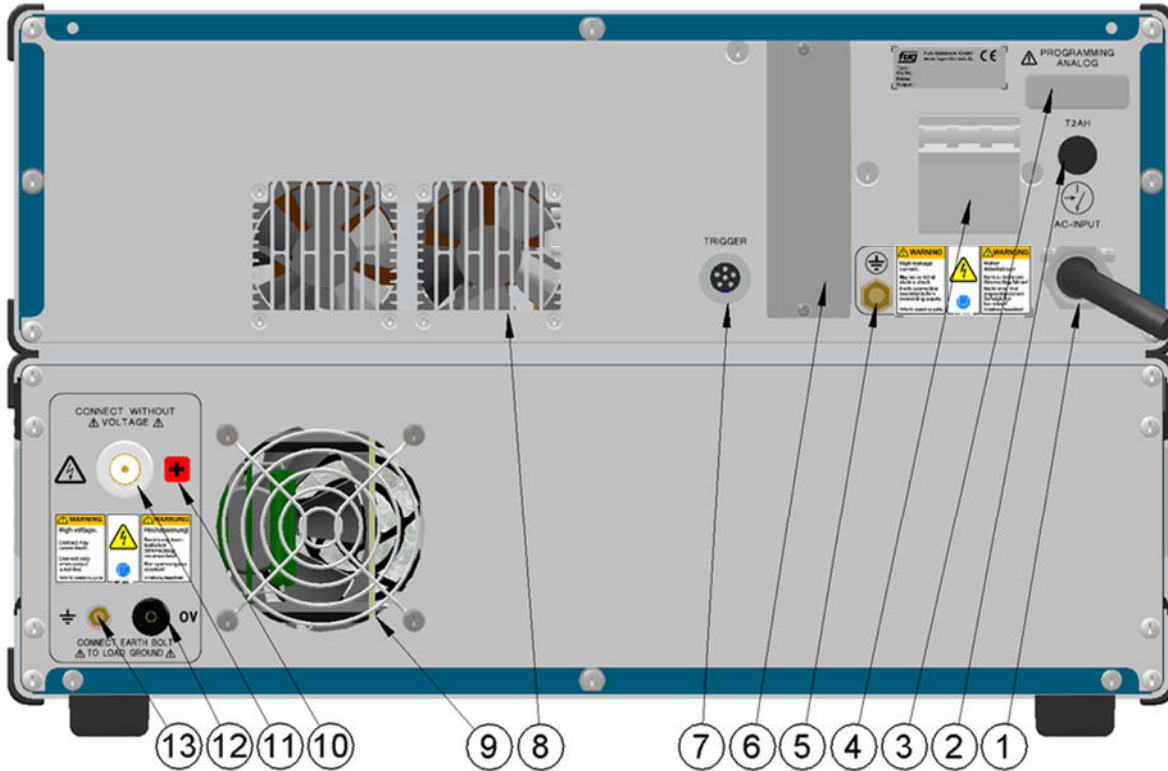
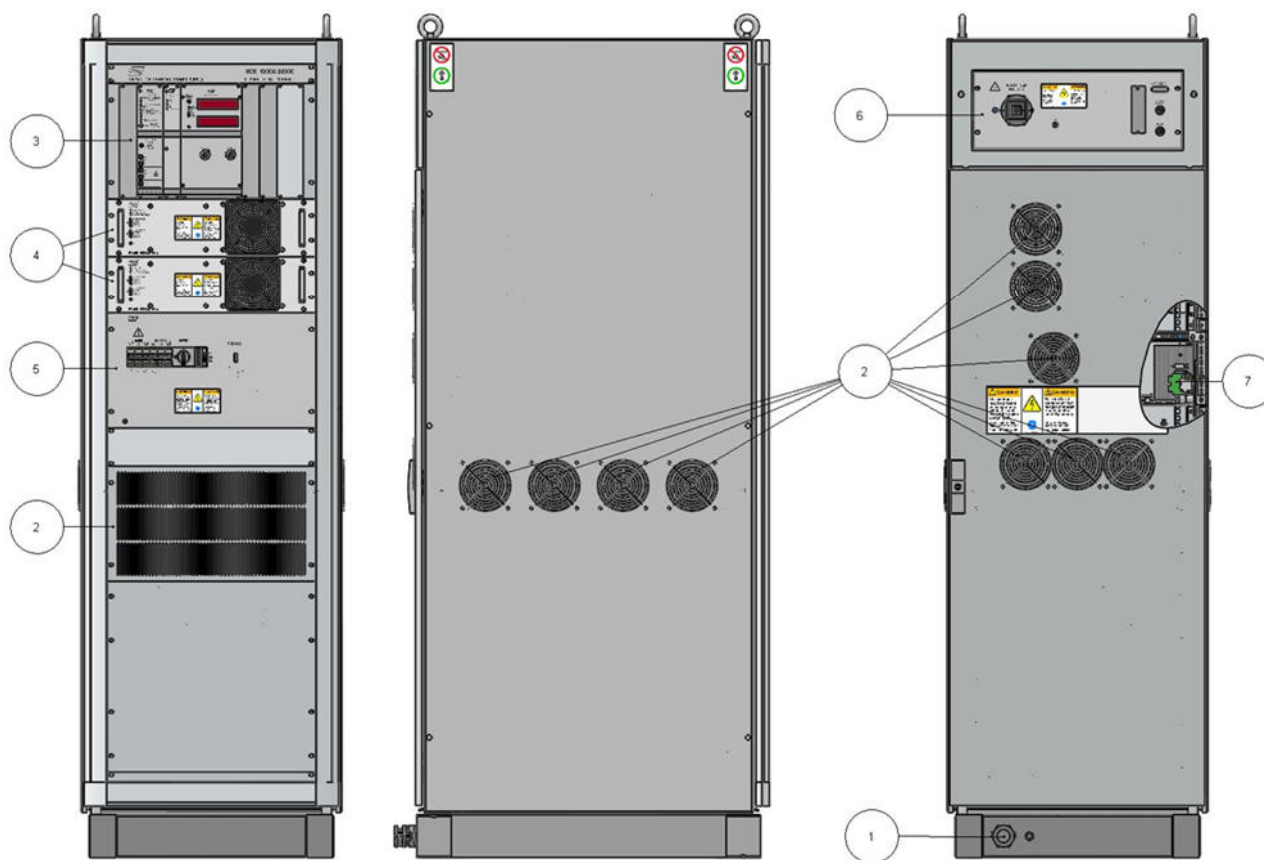

Figure: Three phase AC input - Sample HCK 1600 – 12500. For DC power supplies with higher power or other voltages, other dimensions may apply. The rear panel layout may vary from that shown here.

1	Mains input with fixed installed cable, for 3phase mains
2	Fuse holder for internal electronics fuse
3	(Option) 15pol Sub-D Connection for analog programming
4	Automatic circuit breaker, fuse holder
5	Earthing bolt (only for power supplies with 3phase mains input). These power supplies have to be properly connected to earth via this earthing bolt with 10mm ²
6	Option port for digital interface (e.g., IEEE 488, RS232, USB, LAN)
7	Trigger-socket (Trigger input and “Charge complete” optocoupler output)
8	Air outlet for forced cooling (power output stage)
9	Air outlet
10	Polarity indication RED: POSITIV BLUE: NEGATIV RED/BLUE: OPTION UMPOLUNG POLARITY REVERSAL
11	HV – Output
12	„0V“ terminal, internally connected to 0V of electronics. The “0V” terminal is connected to housing of power supply, to the shielding of the output cable and to PE (earth).
13	Earthing bolt: This terminal must be connected to the earth of the load

DATASHEET CAPACITOR CHARGERS – HCK SERIES

VIEW OF CABINET UNIT: (typical example)



1	AC input
2	Air outlet
3	Electronics
4	Power-driver
5	Mains control
6	HV output
7	Mains connection

CABINET UNIT: FRONT VIEW WITH FRONT PANEL AND AC INPUT (typical example)

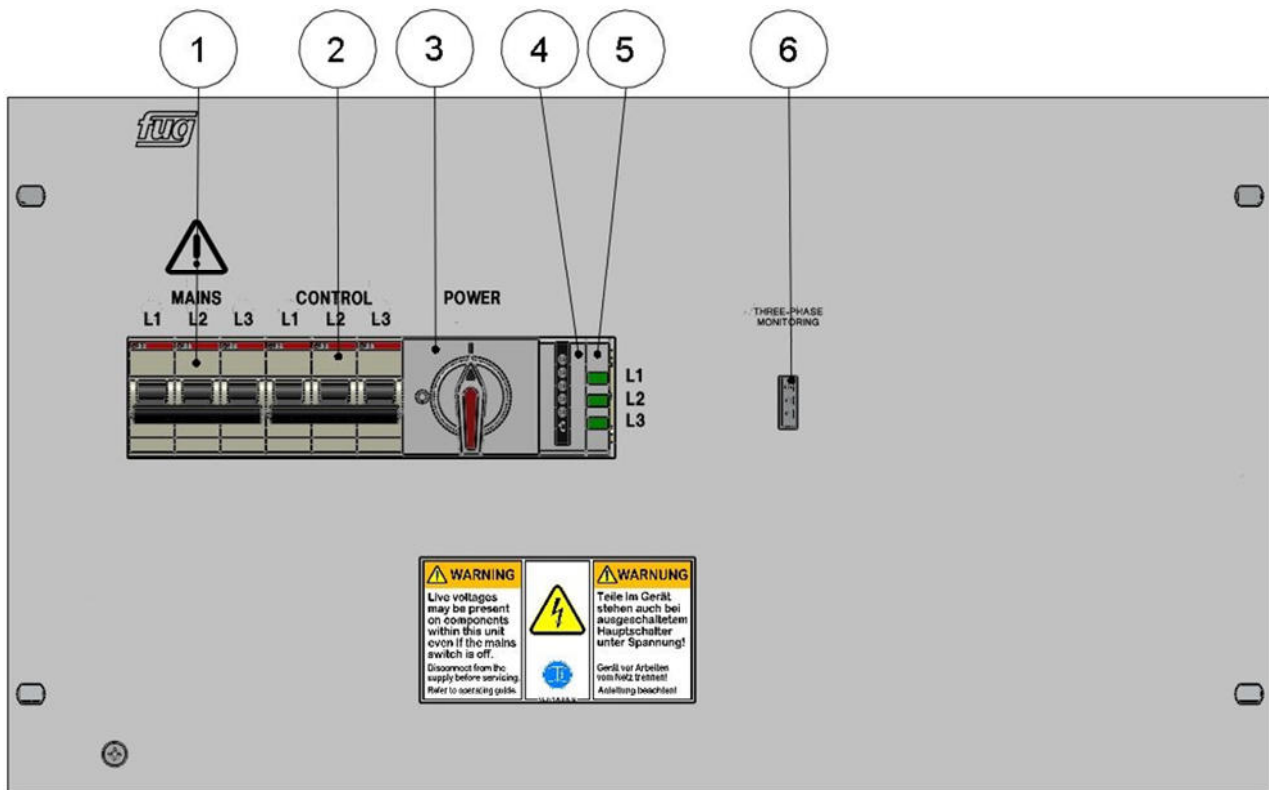

1	Main and automatic circuit breaker, disconnection from the mains
2	Automatic circuit breaker for electronics, no disconnection from the mains
3	Main switch
4	Elapsed hour counter
5	Status LED L1, L2 and L3 (phase display)
6	Phase and mains monitoring relay

DATASHEET CAPACITOR CHARGERS – HCK SERIES

CABINET UNIT: FRONT PANEL AND ELECTRONICS: (typical example)

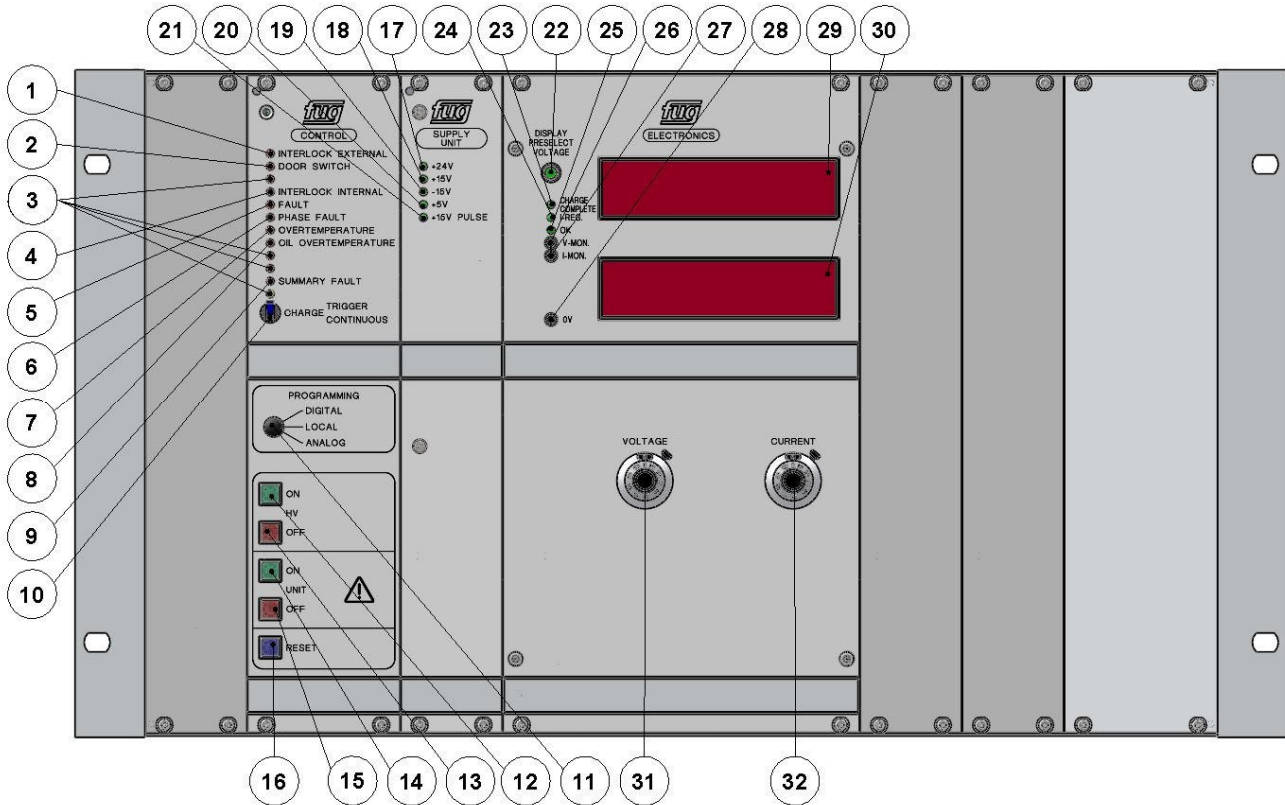

1	LED external interlock loop open	2	LED door open
3	Unused, free available for special features, e.g., smoke alarm, signal of interface	4	LED internal interlock loop open
5	LED internal error	6	LED phase error
7	LED unit overtemperature	8	LED oil overtemperature
9	LED summary fault	10	Charging mode: external Trigger - continuous
11	Programming (optional): digital – local – analog	12	HV on
13	HV off	14	Mains connection on
15	Mains connection off	16	Resetting the error memory
17	LED +24V supply OK	18	LED +15V supply OK
19	LED -15V supply OK	20	LED +5V supply OK
21	LED +15V pulsed power supply OK	22	Switch to display of set values/measured values (voltage)
23	LED charging voltage reached „CHARGE COMPLETE“ (constant voltage mode)	24	LED current control activated „I-REG“
25	LED status OK	26	Socket for voltage monitoring (0-10V)
27	Socket for current monitoring (0-10V)	28	Reference socket „0V“
29	Voltage display (kV)	30	Current display (mA)
31	Fixable ten-turn potentiometer for voltage setpoint	32	Fixable ten-turn potentiometer for current set point

DATASHEET

CAPACITOR CHARGERS – HCK SERIES



CABINET UNIT: POWER DRIVER (typical example)



1	LED internal fuse defective	2	LED asymmetrical voltage at the output stage
3	LED driver overtemperature	4	LED overcurrent part A
5	Socket (internal resistance 10kΩ) for monitoring the primary current of the transformer 10A ± 0.2V	9	
7	Socket for monitoring the PWM signal (PULSE 2A)	6	Socket for monitoring the PWM signal (PULSE 1A)
9	Socket (internal resistance 10kΩ) for monitoring the primary current of the transformer 10A ± 0.2V	8	LED overcurrent part B
11	Socket for monitoring the PWM signal (PULSE 2B)	10	Socket for monitoring the PWM signal (PULSE 1B)
		12	Reference socket "0V"
13	Cooling fan		

STARTING THE CHARGING PROCESS:

The power supplies are equipped with a “CONTINUOUS/TRIGGER” switch (14) and a 6-pin socket. In the “CONTINUOUS” position, charging happens continuously, in the “TRIGGER” position, charging takes place after release by an external signal on the 6-pin interface.

- **Trigger-Signal:** The triggering is floating via an optocoupler. This input is standardised and designed for a control voltage between +12V and +24V. The control power source polarity is positive to pin 5 and negative to pin 6.
- **End of charge:** When the final charging voltage is reached, this is indicated by the "CV" LED (6) illuminating (voltage reached). It is also reported to the external controller via an optocoupler on the trigger connector. This signal is isolated and it is passed through a downstream transistor from the optocoupler. An open collector signal with 100Ω series resistor is available on pins 3 and 4. (The transistor conducts with approx. 50 mA, pin 4 LOW = End of charge).

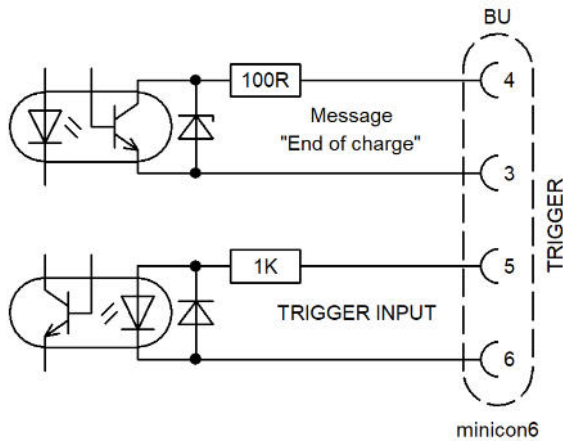

Pin	Trigger connector pin assignment:
1, 2	Not connected
3, 4	„CHARGE COMPLETE“ message
3	EMITTER
4	COLLECTOR
5, 6	„Trigger“ command
5	ANODE
6	COHADE GND

SCOPE OF DELIVERY

- Power supply
- Safety instruction brochure (paper) and operation manual (cloud based in digital form)
- Mains input cable (For single phase mains: with CEE-7/7, for 3 phase mains: open end)
- Mating connectors for control inputs and outputs (Excluded commercially available cables for digital interfaces)
- Screened HV output cable, 3m long, with mating connector assembled on one end, other end open. (For delivery short circuited for safety reasons)

DATASHEET

CAPACITOR CHARGERS – HCK SERIES



TYPE TABLE

Type	Voltage	Current	Charging Power	Width	Height	Depth	Weight
HCK 100 - 2000	0 - 2000 V	0 - 100 mA	100 J/s	19" / 443 mm	3 U / 133 mm	350 mm	6 kg
HCK 200 - 2000	0 - 2000 V	0 - 200 mA	200 J/s	19" / 443 mm	3 U / 133 mm	350 mm	7 kg
HCK 400 - 2000	0 - 2000 V	0 - 400 mA	400 J/s	19" / 443 mm	3 U / 133 mm	350 mm	11 kg
HCK 800 - 2000	0 - 2000 V	0 - 800 mA	800 J/s	19" / 443 mm	3 U / 133 mm	450 mm	12 kg
HCK 1600 - 2000 3)	0 - 2000 V	0 - 1,6 A	1600 J/s	19" / 443 mm	6 U / 266 mm	650 mm	25 kg
HCK 2500 - 2000 3)	0 - 2000 V	0 - 2,5 A	2500 J/s	19" / 443 mm	6 U / 266 mm	650 mm	40 kg
HCK 5000 - 2000 3)	0 - 2000 V	0 - 5 A	5000 J/s	19" / 600 mm	9 U / 399 mm	650 mm	75 kg
HCK 7500 - 2000 3)	0 - 2000 V	0 - 7,5 A	7500 J/s	19" / 600 mm	12 U / 535 mm	650 mm	110 kg
HCK 10000 - 2000 3)	0 - 2000 V	0 - 10 A	10000 J/s	19" / 600 mm	42 U / 2200 mm	800 mm	240 kg
HCK 20000 - 2000 3)	0 - 2000 V	0 - 20 A	20000 J/s	19" / 600 mm	42 U / 2200 mm	800 mm	360 kg
HCK 100 - 3500	0 - 3500 V	0 - 50 mA	100 J/s	19" / 443 mm	3 U / 133 mm	350 mm	6 kg
HCK 200 - 3500	0 - 3500 V	0 - 100 mA	200 J/s	19" / 443 mm	3 U / 133 mm	350 mm	7 kg
HCK 400 - 3500	0 - 3500 V	0 - 200 mA	400 J/s	19" / 443 mm	3 U / 133 mm	350 mm	11 kg
HCK 800 - 3500	0 - 3500 V	0 - 400 mA	800 J/s	19" / 443 mm	3 U / 133 mm	450 mm	12 kg
HCK 1600 - 3500 3)	0 - 3500 V	0 - 800 mA	1600 J/s	19" / 443 mm	6 U / 266 mm	650 mm	40 kg
HCK 2500 - 3500 3)	0 - 3500 V	0 - 1,4 A	2500 J/s	19" / 443 mm	6 U / 266 mm	650 mm	40 kg
HCK 5000 - 3500 3)	0 - 3500 V	0 - 2,8 A	5000 J/s	19" / 600 mm	9 U / 399 mm	650 mm	75 kg
HCK 7500 - 3500 3)	0 - 3500 V	0 - 4,2 A	7500 J/s	19" / 600 mm	12 U / 535 mm	650 mm	110 kg
HCK 10000 - 3500 3)	0 - 3500 V	0 - 5,7 A	10000 J/s	19" / 600 mm	42 U / 2200 mm	800 mm	240 kg
HCK 20000 - 3500 3)	0 - 3500 V	0 - 11 A	20000 J/s	19" / 600 mm	42 U / 2200 mm	800 mm	360 kg
HCK 100 - 6500	0 - 6500 V	0 - 30 mA	100 J/s	19" / 443 mm	3 U / 133 mm	350 mm	6 kg
HCK 200 - 6500	0 - 6500 V	0 - 60 mA	200 J/s	19" / 443 mm	3 U / 133 mm	350 mm	7 kg
HCK 400 - 6500	0 - 6500 V	0 - 120 mA	400 J/s	19" / 443 mm	3 U / 133 mm	350 mm	11 kg
HCK 800 - 6500	0 - 6500 V	0 - 250 mA	800 J/s	19" / 443 mm	3 U / 133 mm	450 mm	12 kg
HCK 1600 - 6500 3)	0 - 6500 V	0 - 500 mA	1600 J/s	19" / 443 mm	6 U / 266 mm	650 mm	35 kg
HCK 2500 - 6500 3)	0 - 6500 V	0 - 750 mA	2500 J/s	19" / 443 mm	6 U / 266 mm	550 mm	40 kg
HCK 5000 - 6500 3)	0 - 6500 V	0 - 1,5 A	5000 J/s	19" / 600 mm	9 U / 399 mm	650 mm	75 kg
HCK 7500 - 6500 3)	0 - 6500 V	0 - 2,3 A	7500 J/s	19" / 600 mm	12 U / 535 mm	650 mm	110 kg
HCK 10000 - 6500 3)	0 - 6500 V	0 - 3 A	10000 J/s	19" / 600 mm	42 U / 2200 mm	800 mm	240 kg
HCK 20000 - 6500 3)	0 - 6500 V	0 - 6 A	20000 J/s	19" / 600 mm	42 U / 2200 mm	800 mm	360 kg
HCK 100 - 12500	0 - 12500 V	0 - 15 mA	100 J/s	19" / 443 mm	3 U / 133 mm	350 mm	6 kg
HCK 200 - 12500	0 - 12500 V	0 - 30 mA	200 J/s	19" / 443 mm	3 U / 133 mm	450 mm	7 kg
HCK 400 - 12500	0 - 12500 V	0 - 60 mA	400 J/s	19" / 443 mm	3 U / 133 mm	450 mm	11 kg
HCK 800 - 12500	0 - 12500 V	0 - 120 mA	800 J/s	19" / 443 mm	3 U / 133 mm	450 mm	21 kg
HCK 1600 - 12500 3)	0 - 12500 V	0 - 250 mA	1600 J/s	19" / 443 mm	6 U / 266 mm	550 mm	35 kg
HCK 2500 - 12500 3)	0 - 12500 V	0 - 400 mA	2500 J/s	19" / 443 mm	6 U / 266 mm	650 mm	40 kg
HCK 5000 - 12500 3)	0 - 12500 V	0 - 800 mA	5000 J/s	19" / 600 mm	9 U / 399 mm	650 mm	75 kg
HCK 7500 - 12500 3)	0 - 12500 V	0 - 1,2 A	7500 J/s	19" / 600 mm	12 U / 535 mm	650 mm	110 kg
HCK 10000 - 12500 3)	0 - 12500 V	0 - 1,5 A	10000 J/s	19" / 600 mm	42 U / 2200 mm	800 mm	240 kg
HCK 20000 - 12500 3)	0 - 12500 V	0 - 3 A	20000 J/s	19" / 600 mm	42 U / 2200 mm	800 mm	360 kg
HCK 100 - 20000	0 - 20000 V	0 - 10 mA	100 J/s	19" / 443 mm	3 U / 133 mm	350 mm**	11 kg
HCK 200 - 20000	0 - 20000 V	0 - 20 mA	200 J/s	19" / 443 mm	3 U / 133 mm	350 mm**	12 kg
HCK 400 - 20000	0 - 20000 V	0 - 40 mA	400 J/s	19" / 433 mm	3 U / 133 mm	450 mm	14 kg
HCK 800 - 20000	0 - 20000 V	0 - 80 mA	800 J/s	19" / 443 mm	4 U / 177 mm	550 mm	25 kg
HCK 1600 - 20000 3)	0 - 20000 V	0 - 160 mA	1600 J/s	19" / 443 mm	6 U / 266 mm	650 mm	35 kg
HCK 2500 - 20000 3)	0 - 20000 V	0 - 250 mA	2500 J/s	19" / 443 mm	7 U / 310 mm	550 mm	40 kg
HCK 5000 - 20000 3)	0 - 20000 V	0 - 500 mA	5000 J/s	19" / 600 mm	29 U / 1500 mm	600 mm	120 kg
HCK 10000 - 20000 3)	0 - 20000 V	0 - 1 A	10000 J/s	19" / 600 mm	42 U / 2200 mm	800 mm	240 kg
HCK 20000 - 20000 3)	0 - 20000 V	0 - 2 A	20000 J/s	19" / 600 mm	42 U / 2200 mm	800 mm	360 kg
HCK 100 - 35000	0 - 35000 V	0 - 5 mA	100 J/s	19" / 443 mm	3 U / 133 mm	350 mm**	12 kg
HCK 200 - 35000	0 - 35000 V	0 - 10 mA	200 J/s	19" / 443 mm	3 U / 133 mm	450 mm	12 kg
HCK 400 - 35000	0 - 35000 V	0 - 20 mA	400 J/s	19" / 433 mm	3 U / 133 mm	550 mm	30 kg
HCK 800 - 35000	0 - 35000 V	0 - 40 mA	800 J/s	19" / 443 mm	4 U / 177 mm	550 mm	30 kg
HCK 1600 - 35000 3)	0 - 35000 V	0 - 80 mA	1600 J/s	19" / 443 mm	6 U / 266 mm	650 mm	50 kg
HCK 2500 - 35000 3)	0 - 35000 V	0 - 140 mA	2500 J/s	19" / 443 mm	7 U / 310 mm	550 mm	50 kg
HCK 5000 - 35000 3)	0 - 35000 V	0 - 280 mA	5000 J/s	19" / 600 mm	42 U / 2200 mm	800 mm	390 kg
HCK 10000 - 35000 3)	0 - 35000 V	0 - 570 mA	10000 J/s	19" / 600 mm	42 U / 2200 mm	800 mm	450 kg
HCK 20000 - 35000 3)	0 - 35000 V	0 - 1,1 A	20000 J/s	2x19" / 1200 mm	42 U / 2200 mm	800 mm	720 kg
HCK 100 - 65000	0 - 65000 V	0 - 3 mA	100 J/s	19" / 443 mm	3 U / 133 mm*	450 mm**	20 kg
HCK 200 - 65000	0 - 65000 V	0 - 6 mA	200 J/s	19" / 443 mm	5 U / 221 mm*	450 mm**	30 kg
HCK 400 - 65000	0 - 65000 V	0 - 12 mA	400 J/s	19" / 433 mm	7 U / 310 mm*	550 mm	55 kg
HCK 800 - 65000	0 - 65000 V	0 - 25 mA	800 J/s	19" / 443 mm	7 U / 310 mm*	550 mm	60 kg
HCK 1600 - 65000 3)	0 - 65000 V	0 - 50 mA	1600 J/s	19" / 443 mm	8 U / 355 mm*	550 mm	80 kg
HCK 2500 - 65000 3)	0 - 65000 V	0 - 75 mA	2500 J/s	19" / 443 mm	10 U / 443 mm*	650 mm	120 kg
HCK 5000 - 65000 3)	0 - 65000 V	0 - 150 mA	5000 J/s	19" / 600 mm	42 U / 2200 mm	800 mm	460 kg
HCK 10000 - 65000 3)	0 - 65000 V	0 - 300 mA	10000 J/s	19" / 600 mm	42 U / 2200 mm	800 mm	500 kg
HCK 20000 - 65000 3)	0 - 65000 V	0 - 600 mA	20000 J/s	19" / 600 mm	33 U / 1800 mm	600 mm***	200/470 kg

DATASHEET

CAPACITOR CHARGERS – HCK SERIES



3) Three phase mains connection

*) With polarity reversal switch these units will be 2 HU higher.

***) With polarity reversal switch these units will be 100mm deeper.

****) The dimensions are valid for the power part. The high voltage part is housed in a separate oil filled container. Weight stated: Power part / High voltage container

All specifications are subject to change without further notice.

Please feel free to contact our sales team for any further questions:

Mail: sales@fug-elektronik.de

Phone: +49 8039 400 77 0